

R255/4 Series (MIL-DTL-38999) Electrical Connectors

Brief introduction

- Comply with R255/4 (MIL-DTL-38999) series
- High density, up to 128 contacts (maximum)
- Various contact types: 22D#, 20#, 16#, 12# power contact, 16#, 12# shielding contact, 12# coaxial contact, 8# twinax contact, 8# quadrax contact, 12#, 16# optic contact (different contacts are interchangeable with each other)
- Straight mating 90° rotation locking structure
- 100% scoop-proof
- With grounding spring to strengthen EMI/RFI shielding
- Various insert arrangement: high & low frequency mixed, high frequency, low frequency, optic fiber, optical & electrical mixed
- Application: Military and aerospace area with high strength vibration environment

Application

The product is used to connect current and signal.

Operating environment

The products can be used in some harsh environment like strong vibration, rain, sand, damp heat and so on.

Main technical characteristics

[Mechanical]

—Vibration

Sinusoid: frequency: 10~2000Hz, acceleration: 588m/s²

Random: frequency: 100~1000Hz, PSD: 1 g²/Hz

—Shock: 3ms half sinusoid, peak value of acceleration: 300g

—Endurance: 500 cycles

[Electrical]

—Contact resistance and rating current

Contact size	Operating dia.(mm)	Contact resistance (mΩ)	Rating current (A)
22D	Φ0.76	≤14.6	5
20#	Φ1.00	≤7.5	7.5
16#	Φ1.60	≤3.7	13
12#	Φ2.40	≤1.83	23
10#	Φ3.15	≤1.0	33
8#	Φ3.60	≤0.57	46

—Insulation resistance

Normal ≥5000M Ω ; high temperature ≥1000M Ω ; damp heat ≥100M Ω

—With standing voltage: V

Service rating*	M	N	I	II
Sea level	1300	1000	1800	2300
21336m	800	600	1000	1000

Remarks: Different insert arrangements have different service rating. Please see the insert arrangement table.

[Environmental]

—Operating temperature:

Y class: -65℃~+175℃, other class: -65℃~+200℃ —

Salt spray: cadmium plating: 500 hours

nickel plating: 48 hours

Ti alloy: 2000 hours

stainless steel: 1000 hours

—Moist proof: According to method GJB150.10, 28 days

—Fluid resistant: Various fuels, coolant, solvent

Contact technical characteristics

[12# coaxial contact]

—Contact resistance

Applicable cable	Inner contact (mΩ)		Outer contact (mΩ)	
	Initial	After test	Initial	After test
SFF-50-2-51	55	66	6.25	7.5
SFF-75-1.6-51	120	144	5.83	7.0

—Low level contact resistance (only for inner contact, max value)

Applicable cable	Initial (mΩ)	After test(mΩ)
SFF-50-2-51	55	66
SFF-75-1.6-51	120	144

—Withstanding voltage: sea level: 1000V; 15240m (11.59KPa): 250V

—VSWR: 500MHz~3GHz, $\leq 1.20+0.04f$

—Insertion loss: dB max=0.11 \sqrt{f} , when frequency is 3GHz, insertion loss ≤ 0.2 dB

—Impedance: 50Ω

—Tensile strength

Applicable cable	Axial load (N)	
	Inner contact	Outer contact
SFF-50-2-51	44.48	66.72
SFF-75-1.6-51	15.57	66.72

—L3438/102 (M39029/102) contacts insert force and withdraw force

Nominal pin dia. (mm)	Min withdraw force (N)		Max insert force (N)	
	Initial	After test	Initial	After test
Φ0.52	---	---	3.34	3.90
Φ0.50	0.14	0.11	---	---

—L3438/103(M39029/103) contacts insert force and withdraw force

Nominal pin dia. (mm)	Min withdraw force (N)		Max insert force (N)	
	Initial	After test	Initial	After test
Φ2.41	---	---	8.35	10.02
Φ2.36	0.83	0.70	---	---

—Vibration: test according to condition V, method 2005, GJB1217 standard, power spectral density 5G2/Hz.

[12# shielding contact]

—Contact resistance:

Inner contact (mΩ)		Outer contact (mΩ)	
Initial	After test	Initial	After test
120	144	5	6

—Low level contact resistance (only for inner contact) : initial 120 mΩ, after test 144 mΩ

—Withstanding voltage: sea level: 1000V; 15240m (11.59KPa): 250V

—Tensile strength: inner contact 15.57 N, outer contact 88.96 N

—L343828(M39029/28) contacts insert force and withdraw force:

Nominal pin dia. (mm)	Min withdraw force (N)		Max insert force (N)	
	Initial	After test	Initial	After test
Φ0.521	---	---	3.34	3.90
Φ0.495	0.14	0.11	---	---

—L3438/75(M39029/75) contacts insert force and withdraw force:

Nominal pin dia. (mm)	Min withdraw force (N)		Max insert force (N)	
	Initial	After test	Initial	After test
Φ2.413	---	---	8.35	10.02
Φ2.362	0.83	0.70	---	---

[16# shielding contact]

—Contact resistance:

Applicable cable	Inner contact (mΩ)		Outer contact (mΩ)	
	Initial	After test	Initial	After test
SFF-50-2-51	55	66	6.25	7.5
SFF-75-1.6-51	120	144	5.83	7.0

—Low level contact resistance (only for inner contact) : initial 120 mΩ, after test 144 mΩ

—Withstanding voltage: sea level: 800V; 15240m (11.59KPa): 250V

[8# twinax contact]

Conditions	Central contact (mΩ)	Middle contact (mΩ)	Outer contact (mΩ)
Initial	55	55	6.25
After test	66	66	7.5
175℃	94	94	10.67

——Low level contact resistance (only for central and middle contact): initial 55 mΩ; after test 66 mΩ

——Withstanding voltage

Operating conditions	Central to middle contact	Middle to outer contact
Sea level	1000 V	500 V
15240m	250 V	125 V

——Frequency: 0~20 MHz

——Rating voltage: normal: 500V, 21336m (4.39KPa) :125V ——

L3438/90(M39029/90) contacts insert force and withdraw force:

Nominal pin dia. (mm)	Min withdraw force (N)		Max insert force (N)	
	Initial	After test	Initial	After test
Φ2.896	---	---	5	6.12
Φ2.845	0.14	0.11	---	---

——L3438/91(M39029/91) contacts insert force and withdraw force:

Nominal pin dia. (mm)	Min withdraw force (N)		Max insert force (N)	
	Initial	After test	Initial	After test
Φ5.563	---	---	13.36	16.7
Φ5.512	0.83	0.56	---	---
Φ0.622	---	---	3.34	3.90
Φ0.597	0.14	0.11	---	---

——Tensile strength:

Applicable cable	Central contact (N)	Middle contact (N)	Outer contact (N)
SEFF-78-1-51	35.59	35.59	111.21

——Vibration: 10~2000Hz, PSD: 1.0G²/Hz

——Shock: acceleration 2940 m/s²

[8# quadrax contact]

——Rating voltage: 500V (sea level) , 125V (21336m height)



—Contact resistance:

Inner contact (mΩ)		Outer contact (mΩ)	
Initial	After test	Initial	After test
15	30	3	4

—Insulation resistance: normal $\geq 5000\text{M}\Omega$; high temperature $\geq 1000\text{M}\Omega$

—Characteristic impedance: 100Ω (100MHz)

—Insertion loss $\leq 0.3\text{dB}$ (100MHz)

—Crosstalk: $\geq 40\text{dB}$ (100MHz)

—insert force and withdraw force: max insert force 11N; min withdraw force 155N

[12#/16# optic contact]

—Insertion loss: $\leq 0.3\text{dB}$ (single fiber)

—Return loss: $\geq 35\text{dB}$ (only for SM optical fiber)

—Interchangeability: insertion loss $\leq 0.6\text{dB}$ (single fiber); return loss $\geq 30\text{dB}$ (only for SM optical fiber)

—Vibration: test according to condition VI, method 2005, GJB1217 standard, letter code J, insertion loss $\leq 1.5\text{dB}$

—Shock: test according to condition D, method 2004, GJB1217 standard, insertion loss $\leq 1.5\text{dB}$

—Operating temperature: $-55^{\circ}\text{C} \sim +125^{\circ}\text{C}$

—Endurance: 500 cycles



Ordering information

Basic series	R255/		62	Y	B	35	P	N	V	RX	01
Type	62— Wall-through square flange receptacle (mounting with backshell) 63— box mounting square flange sealing receptacle (Y class & N class) 64— box mounting square flange receptacle 65— jam nut sealing receptacle (Y class & N class) 66— jam nut receptacle (mounting with backshell) 67— tin soldering sealing receptacle (only for N class) 68— RFI shielding plug (mounting with backshell) 60— fusion welding sealing receptacle (Y class & N class) 61— cable connecting receptacle (mounting with backshell)										
Plating	see plating instruction for details (A class & P class only available for sealing receptacle)										
Shell size											
	Shell code	B	C	D	E	F	G	H	J		
	Shell size	11	13	15	17	19	21	23	25		
Contact layout	see insert arrangement table for details										
Contact type	P-pin	S-socket									
Polarization	N-normal	A, B, C, D, E-alternative									
Modification	V— oil resistance; G— high temperature resistance 260°C (not available for cadmium plating)										
Thermo couple contacts	Rx— R means only one thermo couple contact type, x refers to the contact couples and numbers. (Remarks: if customers need different thermo couple contact types, please contact our engineer.)										
Shell modification code	01~99 (If customers need modification types, add this code to the part number, please contact our engineer for details)										

[Part number example]

R255/68MC35PN

R255 series, 68 shielding plug, plating code M which means stainless steel passivation, C# shell, 35# contact layout, filled with pin, N polarization.

Remarks:

- 1) In ordering information, part“8~10”is the additional instruction for part number, please state it if necessary.
- 2) R255 series is designed according to the same standard with MIL-DTL-38999 series. The difference is that: the basic part number is R255, while MIL - DTL- 38999 is D38999. R255 series is interchangeable with MIL-DTL-38999 series.
- 3) If the operating environment requires oil resistance, the connector sealing components should choose fluorinated silicone rubber. When placing orders, plus V at the end of the original part number (for example: R255/68HC35PNV).

Plating instructions

P/N	Shell material	Plating	Salt spray	Shielding	Temperature
H ¹⁾³⁾	Aluminum alloy	nickel plating	48h	10GHz, 65dB	200°C
Y	Aluminum alloy	olive green cadmium plating	500h	10GHz, 50dB	175°C
M ¹⁾	Stainless steel	passivation	1000h	10GHz, 45dB	200°C
U ¹⁾	Stainless steel	nickel plating	1000h	10GHz, 65dB	200°C
VC ¹⁾	Titanium alloy	—	2000h	10GHz, 65dB	200°C
T ¹⁾	Naval brass	nickel plating	96h	10GHz, 65dB	200°C
A ²⁾	Stainless steel	passivation	500h	10GHz, 50dB	200°C
P ²⁾	Stainless steel	nickel plating	500h	10GHz, 65dB	200°C

- 1) Modification code G means the operating temperature is 260°C.
- 2) A class & P class plating only available for sealing receptacle.
- 3) In R255 IV series, H plating is satin nickel plating, the color is nickel white. Please choose HV plating for accessory ordering. (HV refers to electroless nickel plating.)

Crimping contacts

Contact size	Dia. mm	Pin color	Socket color	ID of crimp boot mm	OD of crimp boot mm	Section of wire mm ²	AWG	Wire insulator OD	Remove tool code	Crimping tool
22D	0.76	Orange-blue-black	Orange-yellow-gray	0.85	1.20	0.08 0.125 0.2 0.3	28 26 24 22	0.76~1.37	M81969/ 14-01	YJQ-02
20#	1.00	Orange-blue-orange	Orange-green-brown	1.17	1.78	0.2 0.3 0.5	24 22 20	1.02~2.11	M81969/ 14-10	YJQ-02 XCXY-01
16#	1.60	Orange-blue-yellow	Orange-green-red	1.68	2.62	0.5 0.8 1.0 1.2	20 18 16	1.65~2.77	M81969/ 14-03	XCXY-01
12#	2.40	Orange-blue-green	Orange-green-orange	2.49	3.84	2.0 3.0	14 12	2.46~3.61	M81969/ 14-04	XCXY-01
10#	3.15	Green-red-gray	Green-orange-purple	3.40	4.65	3.0 4.8	12 10	3.42~4.12	M81969/ 14-05	XCXY-01 YTQ
8#	3.6	—	—	4.55	6.4	8.37	8	6.4~6.9	M81969/ 14-12	YTQ



Soldering contacts

Contact size	Soldering cup ID	AWG
22D	φ0.9	22
20#	φ1.1	20
16#	φ1.9	16
12#	φ2.9	12
10#	φ3.6	10
8#	φ4.8	8

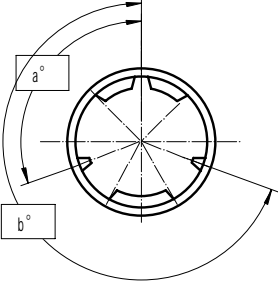
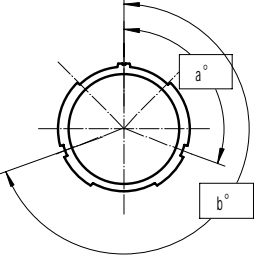
Polarization

	Connection nut key bit angle	Socket housing key bit angle	
			
Polarization code	a	b	
N	110°	250°	
A	100°	260°	
B	90°	270°	
C	80°	280°	
D	70°	290°	
K	120°	255°	

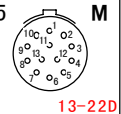
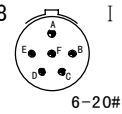
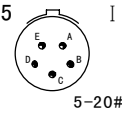
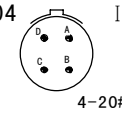
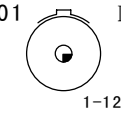
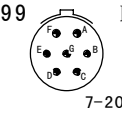
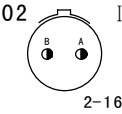
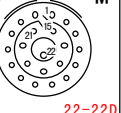
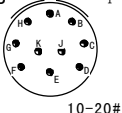
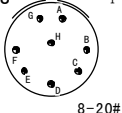
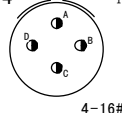
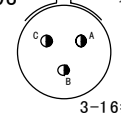
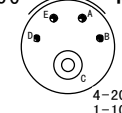
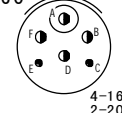
Insert arrangement (mating view of insulator with pin)

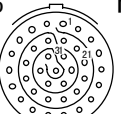
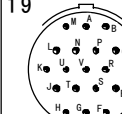
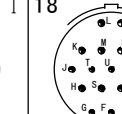
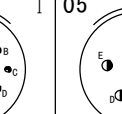
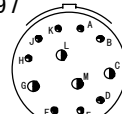
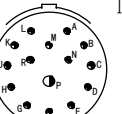
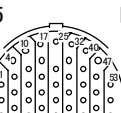
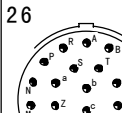
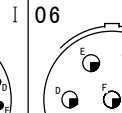
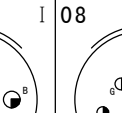
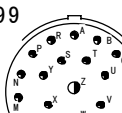
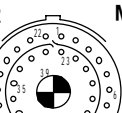
Shell number 11 (B)	35 M  13-22D	98 I  6-20#	05 I  5-20#	04 I  4-20#	01 I  1-12#	99 I  7-20#	02 I  2-16#
13 (C)	35 M  22-22D	98 I  10-20#	08 I  8-20#	04 I  4-16#	03 I  3-16#	50 M  4-20# 1-10#	60 I  4-16# 2-20#
	12 N  1-12# 11-22D						
15 (D)	35 M  37-22D	19 I  19-20#	18 I  18-20#	05 II  5-16#	97 I  8-20# 4-16#	15 I  14-20# 1-16#	
	17 (E)	35 M  55-22D	26 I  26-20#	06 I  6-12#	08 II  8-16#	99 I  2-16# 21-20#	02 M  38-22D 1-8# Double coaxial

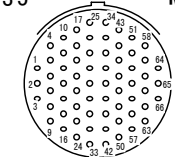
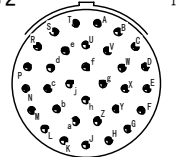
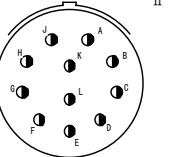
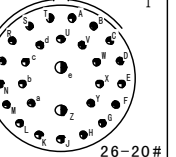
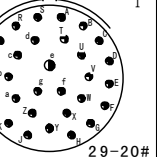
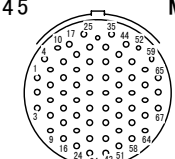
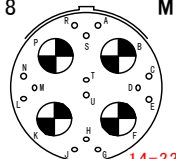
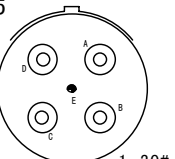
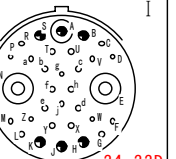
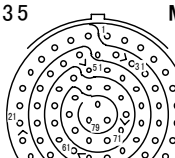
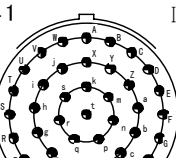
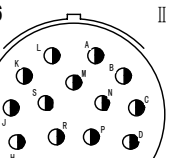
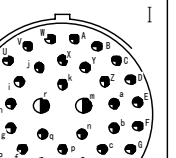
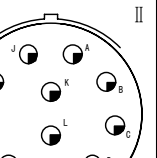
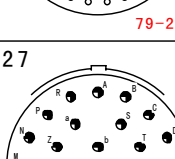
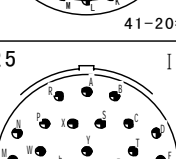
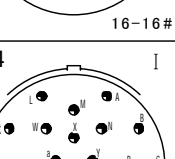
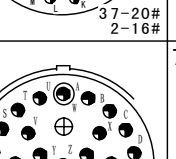
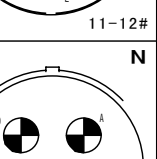
19 (F)	<p>35 M</p>  <p>66-22D</p>	<p>32 I</p>  <p>32-20#</p>	<p>11 II</p>  <p>11-16#</p>	<p>28 I</p>  <p>26-20# 2-16#</p>	<p>30 I</p>  <p>29-20# 1-16#</p>
	<p>45 M</p>  <p>67-22D</p>	<p>18 M</p>  <p>14-22D 4-8# 双同轴</p>	<p>05</p>  <p>1-20# 4-10#</p>	<p>93 I</p>  <p>24-22D 6-20#, 2-10#</p>	
21 (G)	<p>35 M</p>  <p>79-22D</p>	<p>41 I</p>  <p>41-20#</p>	<p>16 II</p>  <p>16-16#</p>	<p>39 I</p>  <p>37-20# 2-16#</p>	<p>11 II</p>  <p>11-12#</p>
	<p>27 I</p>  <p>27-20#</p>	<p>25 I</p>  <p>25-20#</p>	<p>24 I</p>  <p>24-20#</p>	<p>29</p>  <p>26-20# 3-12# Coaxial</p>	<p>75 N</p>  <p>4-8# Double coaxial</p>

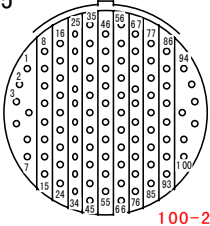
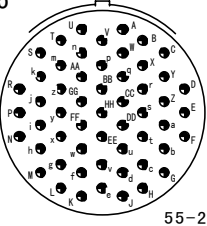
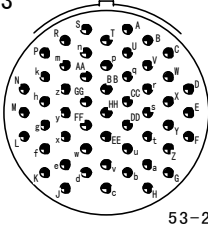
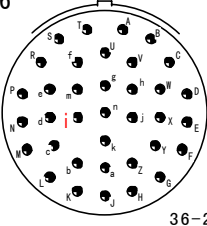
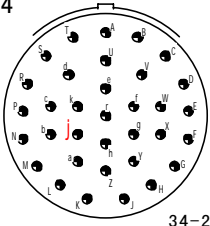
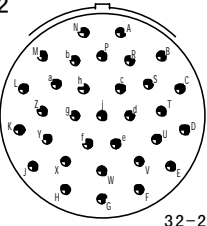
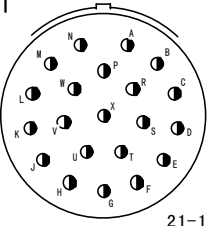
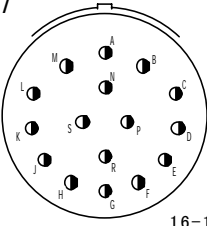
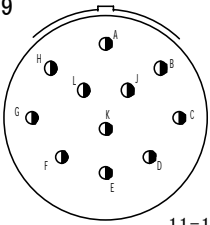
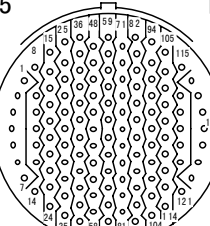
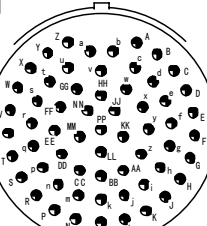
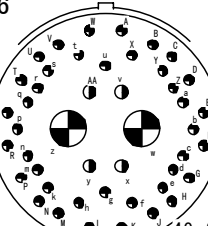
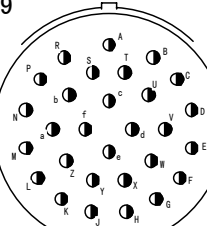
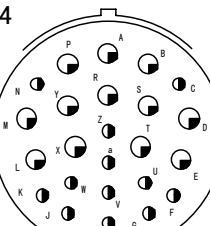
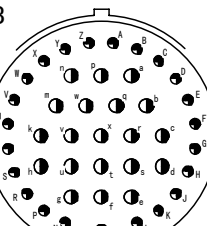
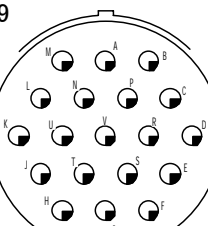
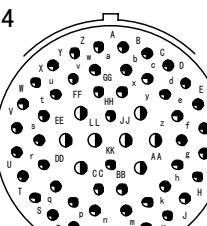
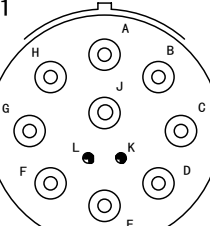
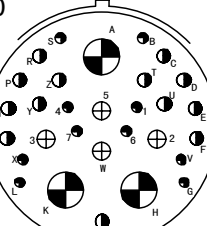
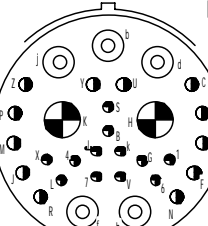
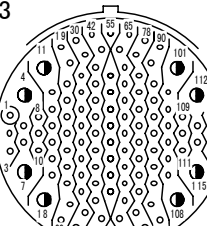
23 (H)	35 M	55 I	53 I	36 I
	 100-220#	 55-20#	 53-20#	 36-20#
	34 I	32 I	21 II	97 I
	 34-20#	 32-20#	 21-16#	 16-16#
	99 II			
	 11-16#			
25 (J)	35 M	61 I	46 I	29 I
	 128-22D#	 61-20#	 40-20# 4-16# 2-8#	 29-16#
	24 I	43 I	19 I	04 I
	 12-16# 12-12#	 23-20# 20-16#	 19-12#	 48-20# 8-16#
11	20 N	31 N	93 M	
 2-20# 9-10#	 10-20# 13-16# 4-12# Coaxial 3-8# Double coaxial	 12-20# 12-16# 5-10# 2-8# Double coaxial	 110-22D# 8-16#	

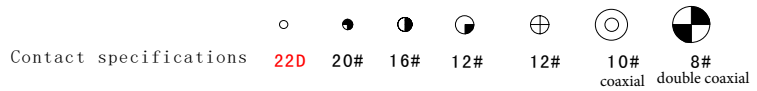
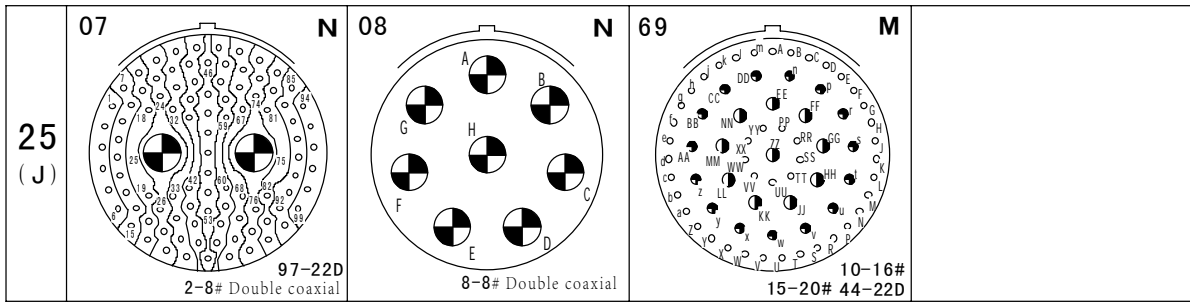

Outline dimensions

[R255/68 shielding plug]

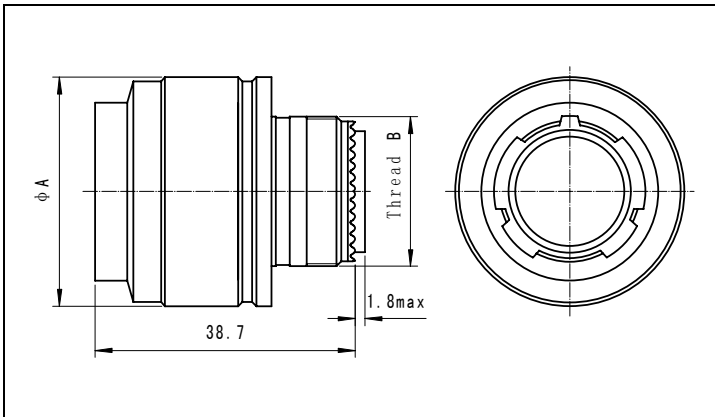

Shell size	Shell code	A max	Thread B (-6g)
11	B	26.6	M15×1
13	C	30.8	M18×1
15	D	34.0	M22×1
17	E	37.4	M25×1
19	F	40.0	M28×1
21	G	43.2	M31×1
23	H	46.5	M34×1
25	J	49.7	M37×1

[R255/62 Wall-through mounting square flange receptacle]

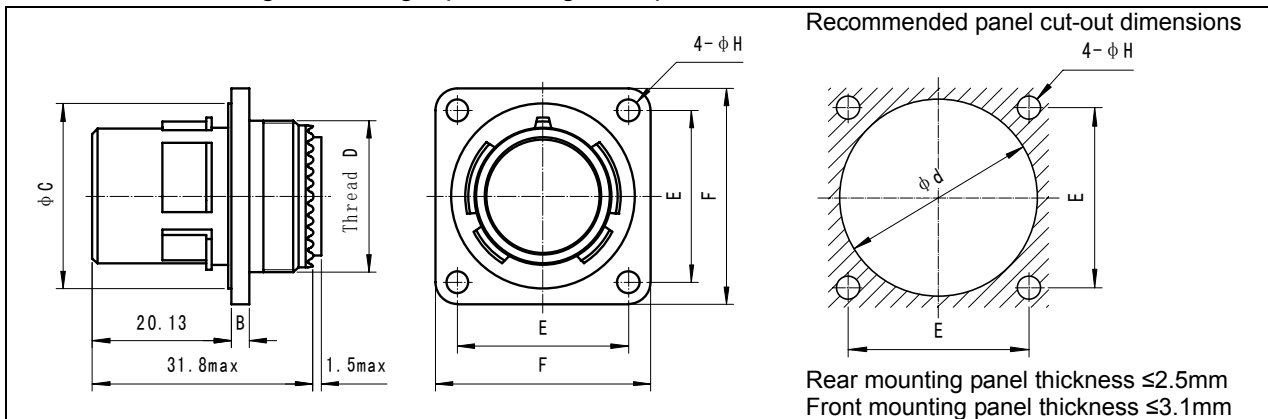

Shell size	Shell code	B max	C max	Thread D (-6g)	E	F	H	d front mount	d rear mount
11	B	2.6	20.1	M15×1	20.62	26.2	3.2	15.3	20.5
13	C	2.6	23.3	M18×1	23.02	28.6	3.2	19.2	23.7
15	D	2.6	26.5	M22×1	24.62	31.0	3.2	23.3	26.9
17	E	2.6	29.66	M25×1	26.98	33.3	3.2	25.9	31.0
19	F	2.6	32.8	M28×1	29.36	36.5	3.2	29.0	33.0
21	G	3.2	36.0	M31×1	31.76	39.7	3.2	32.2	36.2
23	H	3.2	39.2	M34×1	34.92	42.9	3.7	35.0	39.4
25	J	3.2	42.4	M37×1	38.10	46.0	3.7	37.8	42.6



[R255/63 box mounting square flange sealing receptacle]

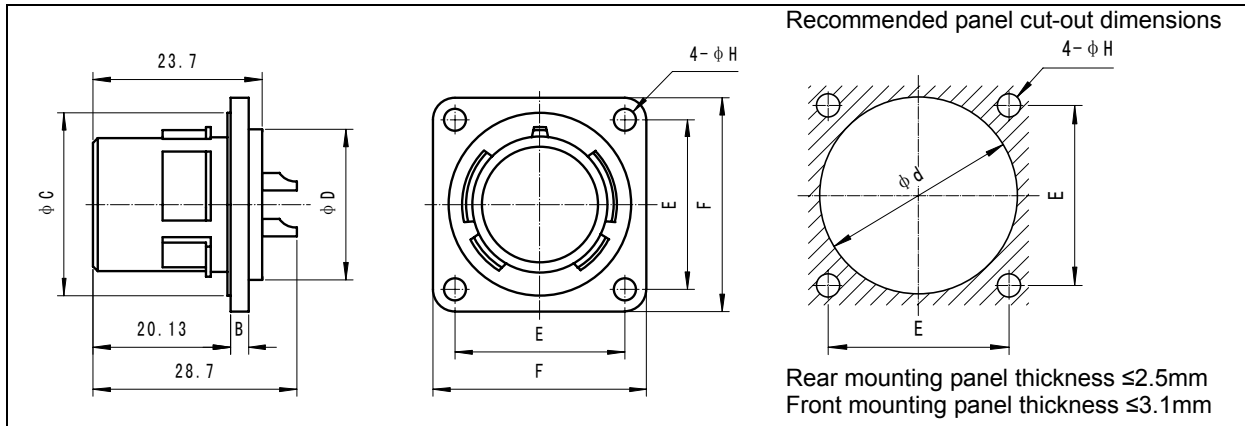

Shell size	Shell code	B max	C max	D	E	F	H	d front mount	d rear mount
11	B	2.6	20.1	15.38	20.62	26.2	3.2	16.0	20.5
13	C	2.6	23.3	18.55	23.02	28.6	3.2	19.0	23.7
15	D	2.6	26.5	22.51	24.62	31.0	3.2	23.0	26.9
17	E	2.6	29.66	25.31	26.98	33.3	3.2	26.0	31.0
19	F	2.6	32.8	29.43	29.36	36.5	3.2	29.8	33.0
21	G	3.2	36.0	31.06	31.76	39.7	3.2	31.8	36.2
23	H	3.2	39.2	34.33	34.92	42.9	3.7	35.0	39.4
25	J	3.2	42.4	37.19	38.10	46.0	3.7	38.0	42.6

[R255/64 box mounting square flange receptacle]

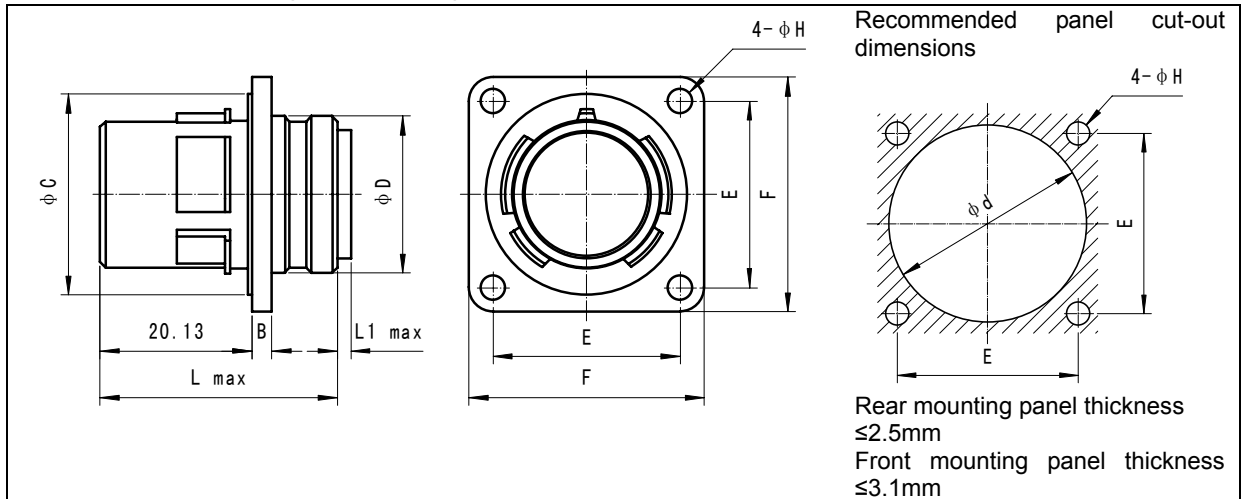

Shell size	Shell code	B max	L	L1	C max	D max	E	F	H	d front mount	d rear mount
11	B	2.6	31.2	2.1	20.1	14.6	20.62	26.2	3.2	15.3	20.5
13	C	2.6	31.2	2.1	23.3	17.5	23.02	28.6	3.2	19.2	23.7
15	D	2.6	31.2	2.1	26.5	20.7	24.62	31.0	3.2	23.3	26.9
17	E	2.6	31.2	2.1	29.66	23.9	26.98	33.3	3.2	25.9	31.0
19	F	2.6	31.2	2.1	32.8	26.6	29.36	36.5	3.2	29.0	33.0
21	G	3.2	31.8	1.5	36.0	29.6	31.76	39.7	3.2	32.2	36.2
23	H	3.2	31.8	1.5	39.2	32.9	34.92	42.9	3.7	35.0	39.4
25	J	3.2	31.8	1.5	42.4	36.1	38.10	46.0	3.7	37.8	42.6



[R255/65 Jam nut sealing receptacle]

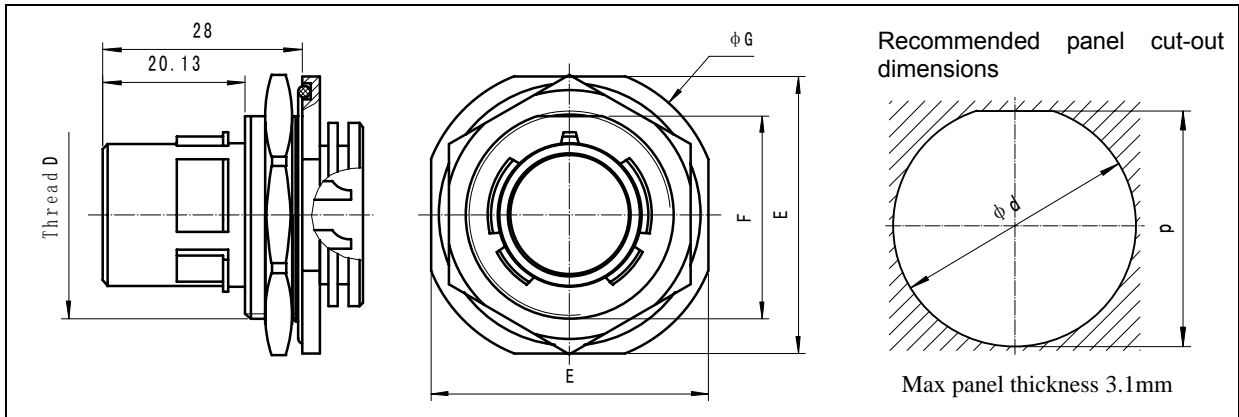

Shell size	Shell code	Thread D (-6g)	E max	F max	G max	d	p
11	B	M20×1	31.6	19.17	34.8	20.5	19.5
13	C	M25×1	34.8	23.92	38.1	25.5	24.3
15	D	M28×1	38.0	27.07	41.2	28.5	27.3
17	E	M32×1	41.1	30.25	44.5	32.5	30.7
19	F	M35×1	45.9	33.44	49.2	35.5	33.8
21	G	M38×1	49.1	36.62	52.3	38.5	37.0
23	H	M41×1	52.2	39.75	55.5	41.5	40.1
25	J	M44×1	55.4	42.98	58.6	44.5	43.1

[R255/66 Jam nut receptacle]

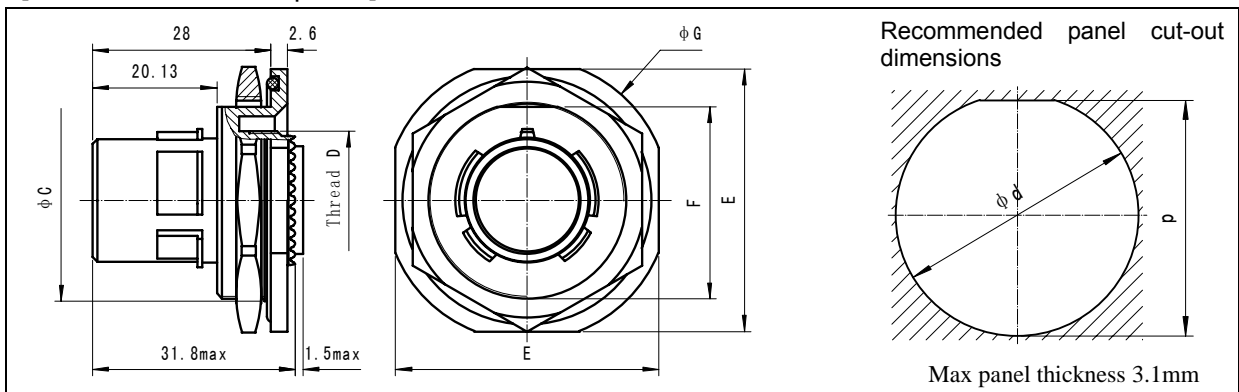

Shell size	Shell code	C max	Thread D (-6g)	E max	F max	G max	d	p
11	B	25.4	M15×1	34.9	23.93	38.1	25.6	24.3
13	C	28.58	M18×1	38.1	27.08	41.2	28.8	27.3
15	D	31.75	M22×1	41.3	30.26	44.5	32.2	30.7
17	E	34.92	M25×1	45.2	33.56	49.2	35.2	33.8
19	F	38.10	M28×1	48.0	36.61	51.2	38.4	37.0
21	G	41.28	M31×1	51.2	39.78	54.3	41.6	40.1
23	H	44.45	M34×1	54.3	42.96	57.5	44.7	43.1
25	J	47.63	M37×1	57.5	46.13	60.7	48.0	46.3



[R255/67 tin soldering sealing receptacle]

Shell size	Shell code	B max	C max	D max	G max	d
11	B	2.6	20.1	19.9	21.9	20.4
13	C	2.6	23.3	23.1	25.1	23.6
15	D	2.6	26.5	26.3	28.2	26.8
17	E	2.6	29.66	29.4	31.4	29.9
19	F	2.6	32.8	31.8	33.8	32.3
21	G	3.2	36.0	35.0	37.0	35.5
23	H	3.2	39.2	38.2	40.2	38.7
25	J	3.2	42.4	41.4	43.3	41.9

[R255/60 fusion welding sealing receptacle]

Shell size	Shell code	C max	D max	G	d
11	B	20.1	15.38	28.0	16.18
13	C	23.3	18.55	31.2	19.35
15	D	26.5	22.51	34.3	23.31
17	E	29.66	25.31	36.6	26.11
19	F	32.8	28.48	40.3	29.28
21	G	36.0	31.66	43.9	32.46
23	H	39.2	34.33	48.1	35.13
25	J	42.4	37.19	50.3	37.99

[R255/61 cable connecting receptacle]

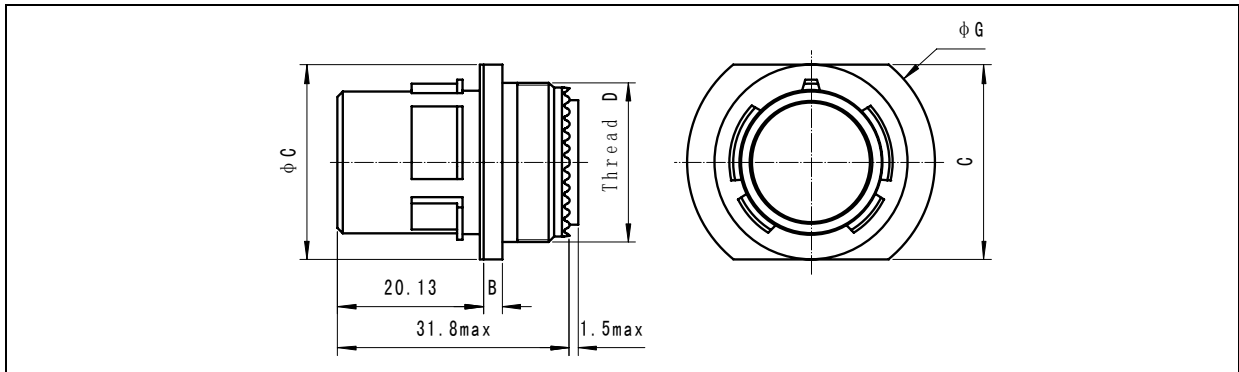

Shell size	Shell code	B max	C max	Thread D (-6g)	G
11	B	2.6	20.1	M15×1	26.5
13	C	2.6	23.3	M18×1	29.9
15	D	2.6	26.5	M22×1	34.0
17	E	2.6	29.66	M25×1	37.2
19	F	2.6	32.8	M28×1	40.0
21	G	3.2	36.0	M31×1	43.1
23	H	3.2	39.2	M34×1	46.3
25	J	3.2	42.4	M37×1	49.6

Instructions:

When using the product, first of all put the plug to the right place (contact jam nut surface meet the receptacle). Then rotate the contact jam nut 90° clockwise. The connectors mated after a clear cluck and an obvious handle; meanwhile the red color ring of the plug is covered completely. To withdraw the connector, just rotate the contact jam nut 90° anticlockwise. The connectors disconnected with each other after a clear cluck and an obvious handle; meanwhile the red color ring of the plug is appeared.

Backshell

The applicable backshell is the same with R255 III Series.



Sealing cap of plug and receptacle

Ordering information

Basic series	R255	73	H	15	N
Type	72—sealing cap of plug (MIL code is D38999/51) 74—sealing cap of receptacle (MIL code is D38999/52)				
Plating	Y—aluminum shell, olive green cadmium plating H—aluminum shell, electroless nickel plating				
Shell size	11-13-15-17-19-21-23-25				
Chain type	R—stainless steel chain with connecting lug (for square flange receptacle) C—nylon string with connecting lug (for square flange receptacle) N—stainless steel chain with ring (for jam nut receptacle) E—nylon string with ring (for jam nut receptacle)				

Remarks: The sealing cap is ordered separately, not supplied with the connectors.

[Sealing cap of plug]

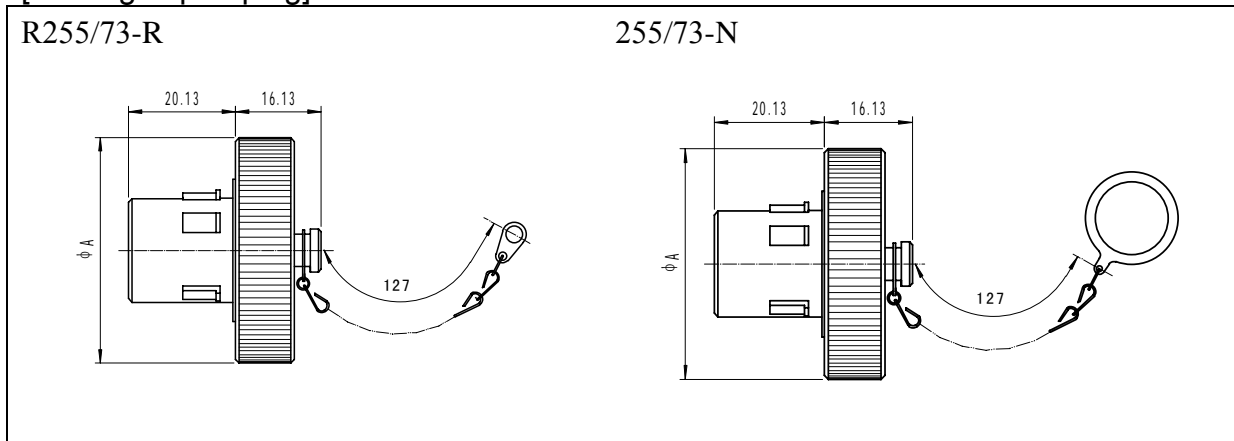

[Sealing cap of receptacle]

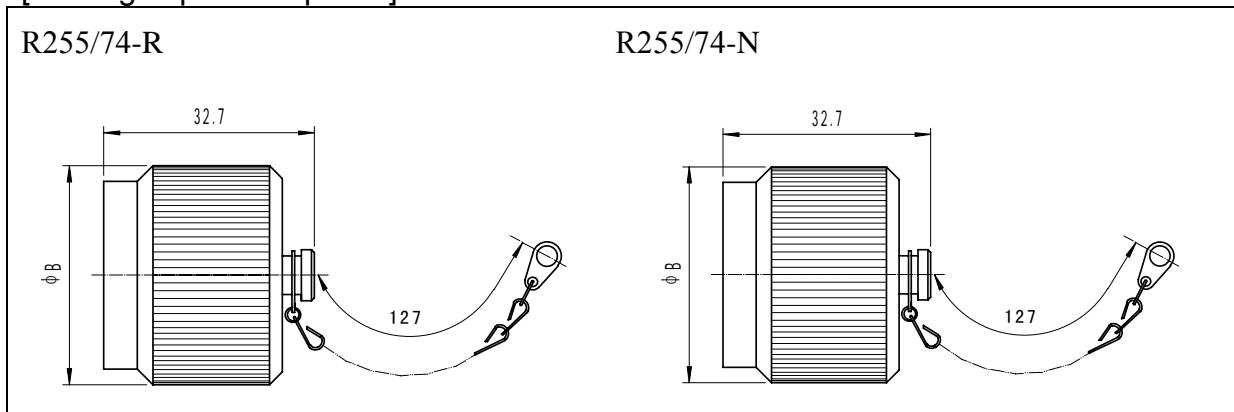

Shell size	11	13	15	17	19	21	23	25
Shell code	B	C	D	E	F	G	H	J
A	35.05	39.88	42.16	45.47	48.77	52.32	57.15	56.85
B	23.42	26.59	30.96	34.14	37.31	40.11	43.28	46.46