

shell size	L(Max)	A	B(Max)	C(Max)	D(Max)	E	F(Max)	J
8	28	12.04	11.7	1.7	10.84	15.09	20.99	3.2
10	28	15.0	11.7	1.7	13.99	18.26	24.19	3.2
12	28	19.07	11.7	1.7	17.37	20.62	26.54	3.2
14	28	22.25	11.7	1.7	20.57	23.0	28.89	3.2
16	28	25.43	11.7	1.7	23.72	24.61	31.29	3.2
18	28	28.6	11.7	1.7	26.69	26.97	33.69	3.2
20	28	31.78	14.35	2.5	29.89	29.36	36.89	3.2
22	28	34.95	14.35	2.5	33.04	31.75	39.99	3.2
24	28	38.13	15.2	2.5	36.24	34.92	43.15	3.5

[Jam nut receptacle, R class] LA3114R

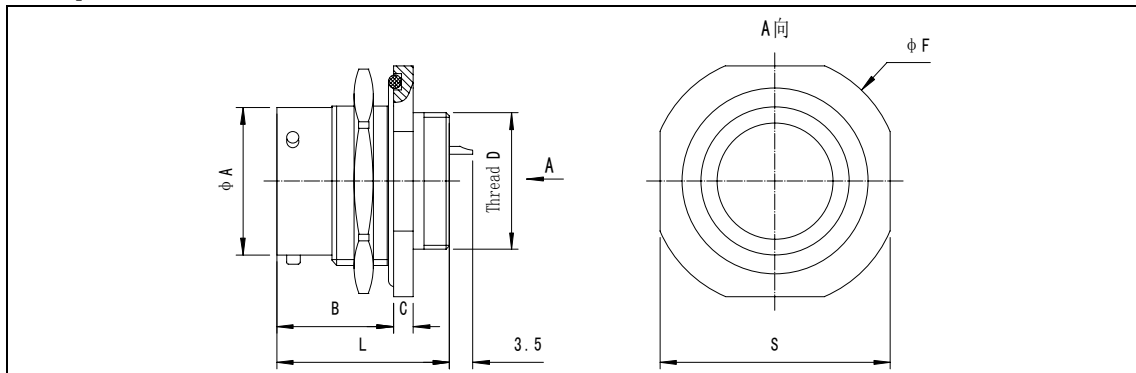

Shell size	L(Max)	A	B(Max)	C(Max)	F(Max)	S(Max)	Thread screw D UNEF-2A
8	28	12.04	17.9	3	26.94	23.94	0.4375-28
10	28	15.0	17.9	3	30.14	26.94	0.5625-24
12	28	19.07	17.9	3	34.94	31.74	0.6875-24
14	28	22.25	17.9	3	38.04	34.94	0.8125-20
16	28	25.43	17.9	3	41.24	38.24	0.9375-20
18	28	28.6	17.9	3	44.44	41.34	1.0625-18
20	28	31.78	22.4	3.8	49.14	46.04	1.1875-18
22	28	34.95	22.4	3.8	52.24	49.24	1.3125-18
24	28	38.13	23.3	3.8	55.54	52.74	1.4375-18

[Jam nut receptacle, B  
class] LA3114B

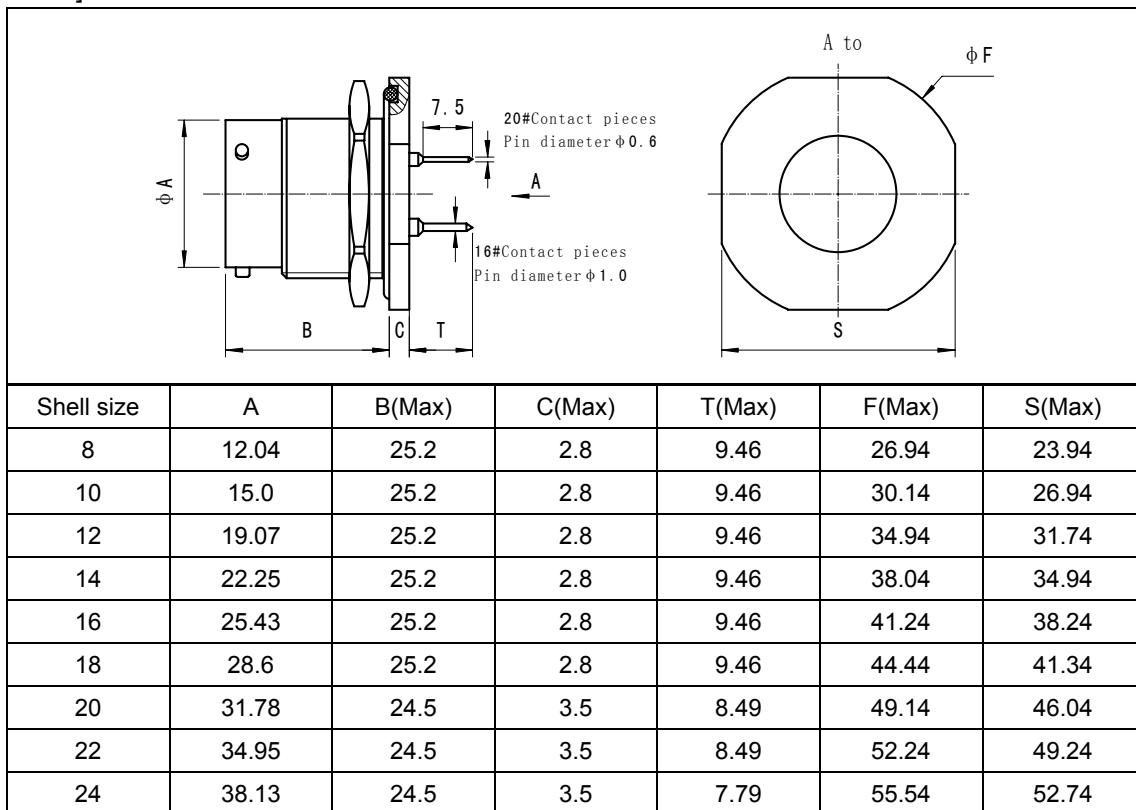

### Panel cut-out dimensions

Square plate installation socket

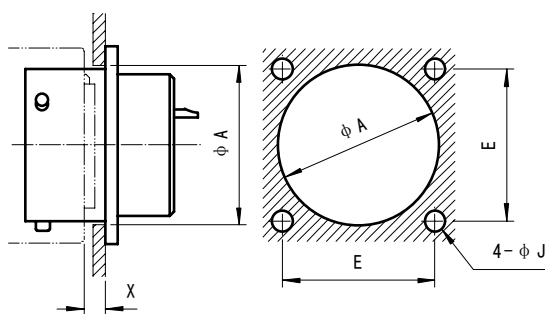



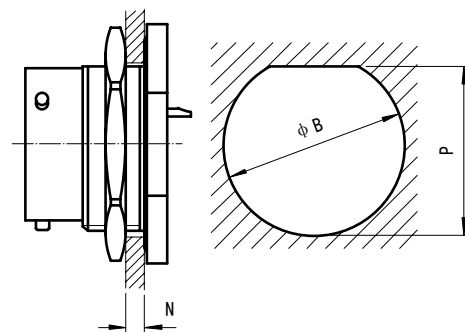















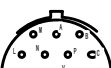











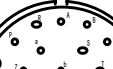

Nuts tighten the mounting sockets

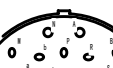

Shell number	A	E	J	X (Min)	B	P	N	
							(Min)	(Max)
8	15.55	15.09	3.2	2.9	14.60	13.75	1.8	5.7
10	18.80	18.26	3.2	2.9	17.75	16.95	1.8	5.7
12	22.15	20.62	3.2	2.9	22.50	21.50	1.8	5.7
14	25.30	23.00	3.2	2.9	25.70	24.20	1.8	5.7
16	28.45	24.61	3.2	2.9	28.85	27.35	1.8	5.7
18	31.65	26.97	3.2	2.9	32.05	30.55	1.8	5.7
20	34.80	29.36	3.2	5.5	35.20	33.70	1.8	8.6
22	38.00	31.75	3.2	5.5	38.40	36.90	1.8	9.6
24	41.20	34.92	3.8	5.5	41.55	40.05	1.8	9.5

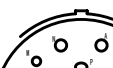
Contact layout (front face of pin inserts illustrated)

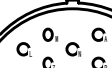
Shell number 08	33  3-20#	98  3-20#	2  2-20#	4  4-20#		
10	6  6-20#	98  6-20#				
12	10  10-20#	3  3-16#	8  8-20#	4  4-16#		
14	19  19-20#	18  18-20#	15  14-20# 1-16#	12  8-20# 4-16#	5  5-16#	4  4-12#
16	26  26-20#	23  22-20# 1-16#	8  8-16#			
18	32  32-20#	30  29-20# 1-16#	11  11-16#			
20	41  41-20#	24  24-20#	27  27-20#	39  37-20# 2-16#	16  16-16#	
22	55  55-20#	34  34-20#	32  32-20#	41  27-20# 14-16#	21  21-16#	
24	61  61-20#	31  31-16#				

