

## IF Optical-Electrical Mixed Connectors

The optical-electrical mixed connectors are loaded with optical fiber contacts and electrical contacts. By one connection, optical signal and electrical signal can be simultaneously connected. At present, optical-electrical mixed connectors with many insert arrangements are designed according to customer's requirements.

### Description

- Metal shell, durable
- Five key orientation to blind mate and avoid mis-mating
- Thru-bulkhead sealed structure
- Simultaneously connecting optical and electrical signals
- Ceramic ferrule and sleeve, PC and UPC polishing
- Optical fiber contacts or electrical contacts are installed on 12# and 16# cavity
- EMI shielding
- Company standard: Q/21EJ279

### Applications

- Military communication network
- Military computer system
- Vehicle carrier, air-borne or ship-borne

### Main technical characteristic

[Electrical]

—Insertion loss:  $\leq 1.0$ dB per fiber

[Electrical]

—Contact resistance and rated current:

Contact size	Contact resistance m $\Omega$	Rated current A
22D#	$\leq 12$	5
20#	$\leq 5$	7.5
16#	$\leq 2.5$	13
12#	$\leq 1.5$	23
10#	$\leq 1.0$	40

—Withstanding voltage: (Vrms)

Operation condition	Sea level	21000 meter
I	1800	1000
II	2300	1000

Note: Different operation condition are applicable to different insert arrangement, see insert arrangement

—Insulation resistance: more than or equal to 5000M $\Omega$  at 500Vdc

[Environmental]

—Thermal shock: -55 $^{\circ}$ C~85 $^{\circ}$ C

—Salt spray: 48 hour (aluminum alloy, nickel plating), 500 hour(stainless steel)

[Mechanical]

- Shell: aluminum alloy, stainless steel
- Electrical contact: copper alloy, gold plating
- Insulator: thermoplastic or thermosetting
- Grommet and sealing ring: silicon rubber
- Vibration: 10Hz -2000Hz, acceleration 196m/s<sup>2</sup>
- Shock: half-sine wave, acceleration peak value 2940 m/s<sup>2</sup>
- Durability: 500 cycles

**Ordering Information**

Basic series	IF	18	F	2G2	Z	07
Shell size	12, 18, 22, 25...					
Type	T—Plug; F—Square flange receptacle					
Insert arrangement	See insert arrangement Figure before G denotes the number of optical fiber contact Figure after G denotes the number of electrical contact					
Electrical contact type	Z—Pin; K—Socket					
Design number	01, 02...					

**Insert arrangement (Front face of pin insert)**

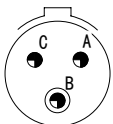
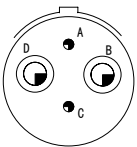
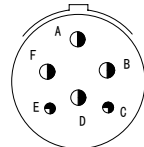
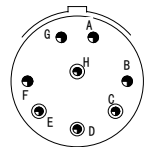
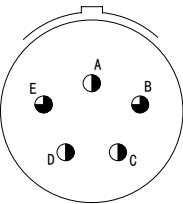
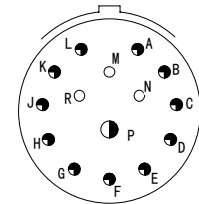
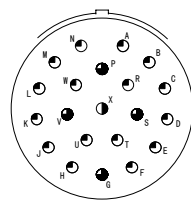
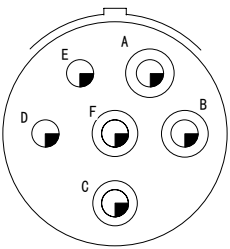
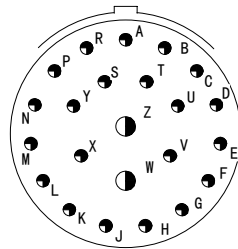
Shell size IF 12	1G2 I 		
IF 18	2G2 I 	4G2 I 	4G4 I 
IF 22	3G2 II 	1G12 I 	1G20 I 
IF 25	4G2 I 	2G21 I 	

- 20 # Light
- 20#Electricity
- Vacant
- 22#Electricity
- 16#Light
- 16#Electricity
- 12 # light
- 12#Electricity

### Outline dimensions

[Plug assembly]

	Shell size	C Max	L Max
	IF 12	21.80	82
	IF 18	29.40	102
	IF 22	32.50	80
	IF 25	35.60	100

Note: L dimension designates the maximum dimension of the shell size and the actual length may vary depending on the cable

[Receptacle assembly]

		<p>After the equipment</p>	<p>Before loading</p>				
		Maximum thickness of the panel 2.5mm	Maximum thickness of the panel 3.2mm				
Shell size	Thread D	E	F	G	H	d1 Min.	d2 Min.
IF 12	M12×1-6g	23.80	18.26	15.09	3.25	16.66	13.11
IF 18	M18×1-6g	29.00	23.01	20.62	3.25	23.42	19.05
IF 22	M22×1-6g	31.00	24.61	23.01	3.25	26.59	23.01
IF 25	M25×1-6g	33.30	26.97	24.61	3.25	30.96	25.81

### Cable assembly

[I type optical fiber cable assembly]

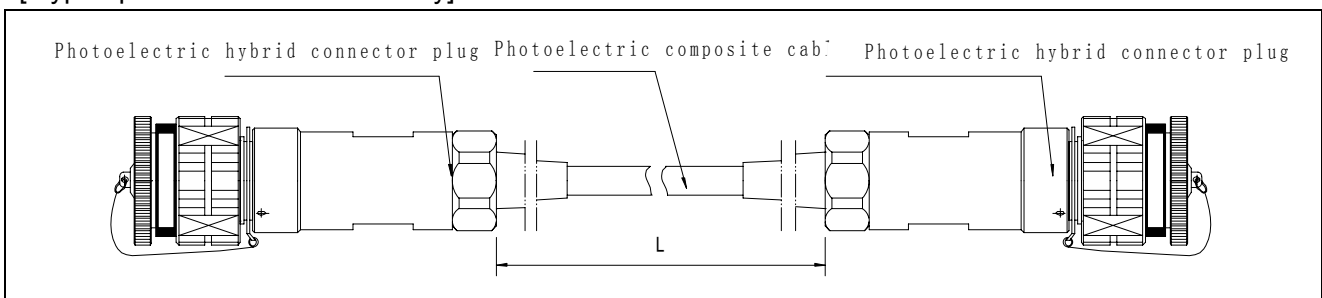

[Ordering information]

1 end plug type	IF 18T2G2Z	- IF 18T2G2Z	-S	2
2 end plug type				
Transmission mode	S : Single mode G. 652 M : Multiple mode 62.5/125 MI : Multiple mode 50/125			
Cable length L	According to customer's requirement, unit: m			

[II type cable assembly]

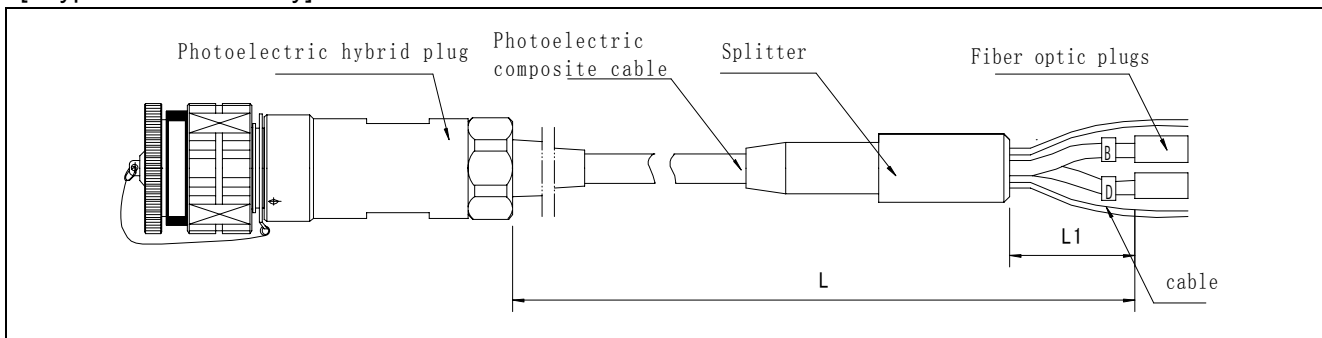

[Ordering information]

1 end plug type	IF 18T2G2Z	-2FC	-2	S	1	/0.1
Quantity and type of 2 end plug	Quantity: blank -1 Type: FC and SC, etc., or according to customer's requirement					
Diameter of the branch cable	2-φ2mm 3-φ3mm					
Transmission mode	S: signal mode G. 652 M: multiple mode 62.5/125 MI: multiple mode 50/125					
Length of cable L	According to customer's requirement, unit: m					
Length of branch cable L1	According to customer's requirement, unit: m					

[III type cable assembly]

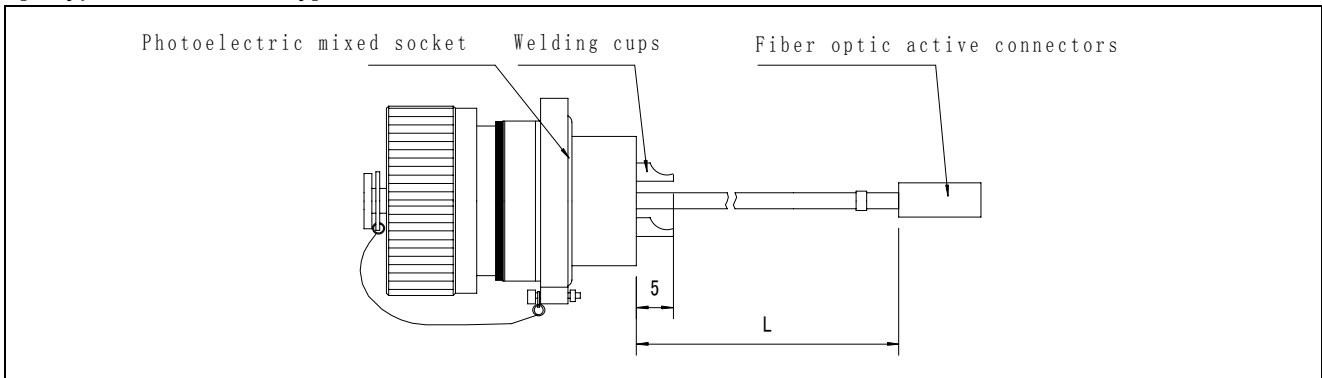

[Ordering information]

1 end plug type	IF 18T2G2Z	-2FC	S	-2	-L1
Quantity and type of 2 end plug	Quantity: blank -1 Type: FC and SC, etc., or according to customer's requirement				
Transmission mode	S: signal mode G. 652 M: multiple mode 62.5/125 MI: multiple mode 50/125				
Diameter of optical fiber cable	2-φ2mm 3-φ3mm				
Length of optical fiber cable L	According to customer's requirement, unit: m				

- Notes: 1) Stainless steel shell,  
 2) Movable plug can be MTRJ, DLC, SC, ASC, FC, AFC, ST, LC and MU, etc;  
 3) L and L1 are in accordance with the customer's requirement